



# CORNER SHOWER CURTAIN ROD

## BEFORE INSTALLING

Read entire shower rod installation Instructions. Observe all local building and safety codes. For the following installation instructions it is assumed that any old fixtures have been removed and any repairs to the wall have been completed.

## INSTRUCTIONS

Unpack and inspect the product for any shipping damages. If you find damages, do not install. Contact Customer Service at 1.866.855.2284. If you need assistance or have questions while installing your shower rod contact Customer Service.

We recommend consulting a professional if you are unfamiliar with installing bathroom fixtures. Signature Hardware accepts no liability for any damage to the walls or ceiling, or for personal injury during installation.

## TOOLS AND MATERIALS:



Drill



Level



Tape Measure



Screwdriver



Pencil



Hammer

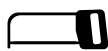

Hacksaw



1/4" Drill Bit

## INSTALLATION

1. Lay the rod sections on the floor. Assemble the rod with the connector piece.

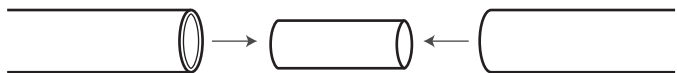

2. Verify that the rod sections are the proper length for your installation. If not, trim with a hacksaw.

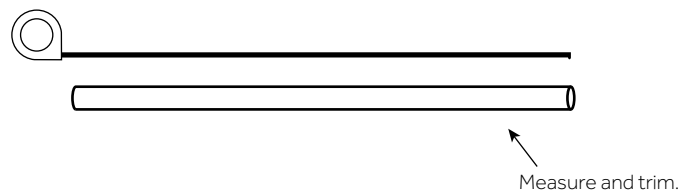

3. Hold the wall brackets up at the desired mounting height.

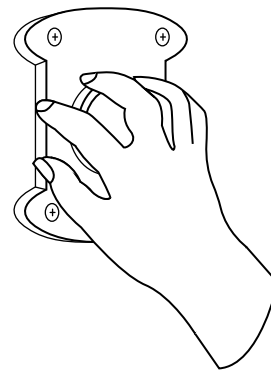



# CORNER SHOWER CURTAIN ROD

## INSTALLATION

4. Mark the placement of the mounting holes. Use a tape measure and level to make sure that your pencil marks are lined up properly on each wall.

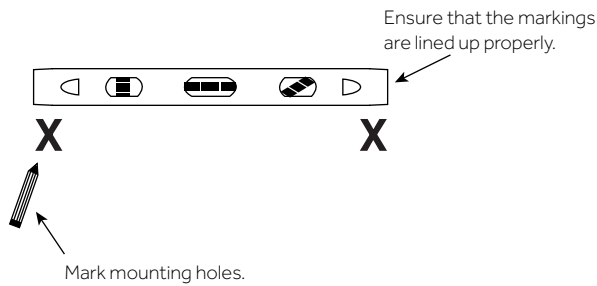

5. Drill pilot holes for the wall anchors.

**Note:** If there is a stud in your mounting location, use wood screws to attach the wall brackets.

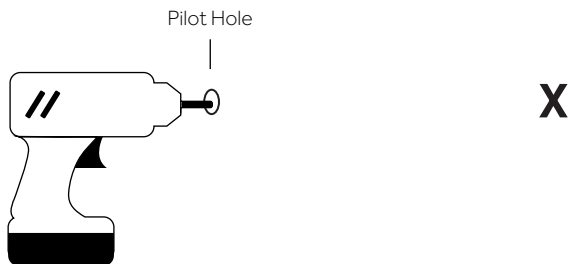

6. Gently tap the anchors into the pilot holes with a hammer.

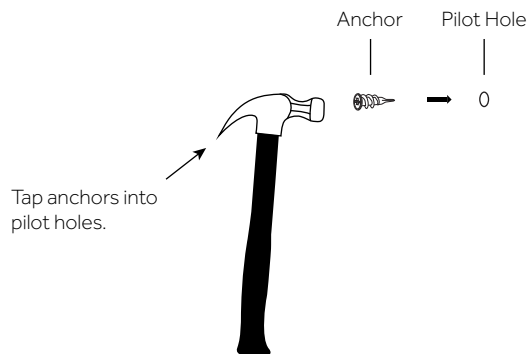

7. Attach the rod and brackets to the wall with the mounting hardware provided.

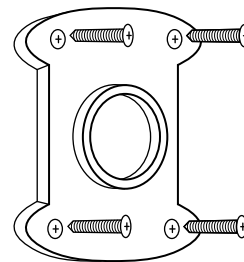

8. Slide the 1" loop onto the curved section of the rod.

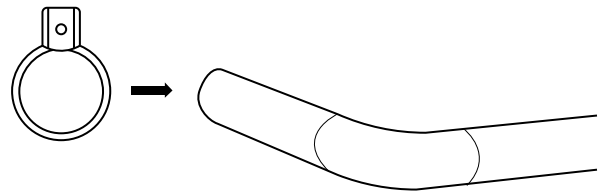

9. Insert the ends of the rod into the wall brackets. Tighten the set screws with a Philips head screwdriver to secure.

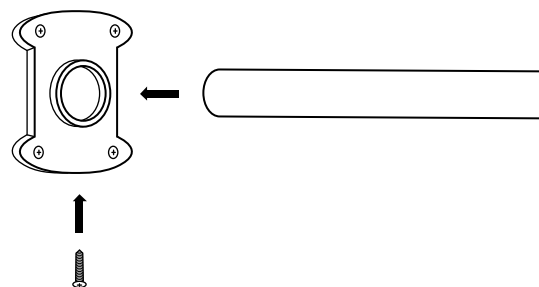



## CORNER SHOWER CURTAIN ROD

### INSTALLATION

10. Mark the location of the ceiling support and measure the distance between the ceiling and the rod. If necessary, trim the ceiling support to the proper length with your hacksaw.

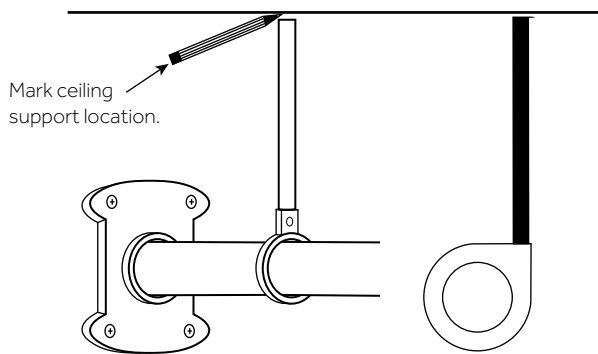

11. Once the support is ready, insert it into the 1" loop. Attach the ceiling bracket to the other end and tighten the set screws.

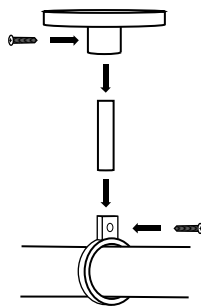

12. Hold the ceiling support in place and mark the location of the mounting holes.

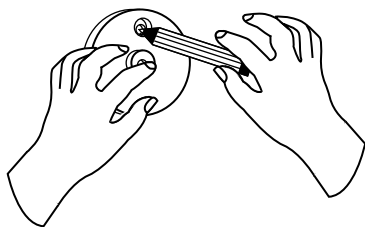

13. Drill pilot holes for the anchors and tap the anchors in with a hammer.

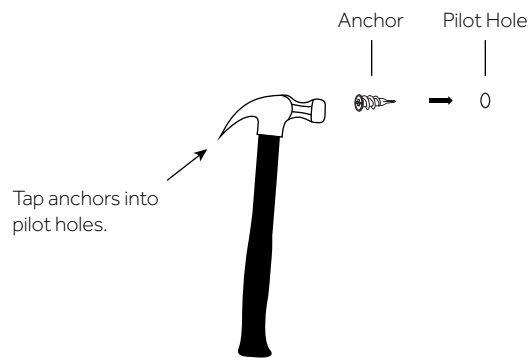

14. Attach the ceiling bracket.

