

NEWPORT BRASS.
The Luxury of Style

WIDESPREAD LAVATORY SET INSTALLATION INSTRUCTIONS

Model No: 930, 930L, 1000, 1030, 2100

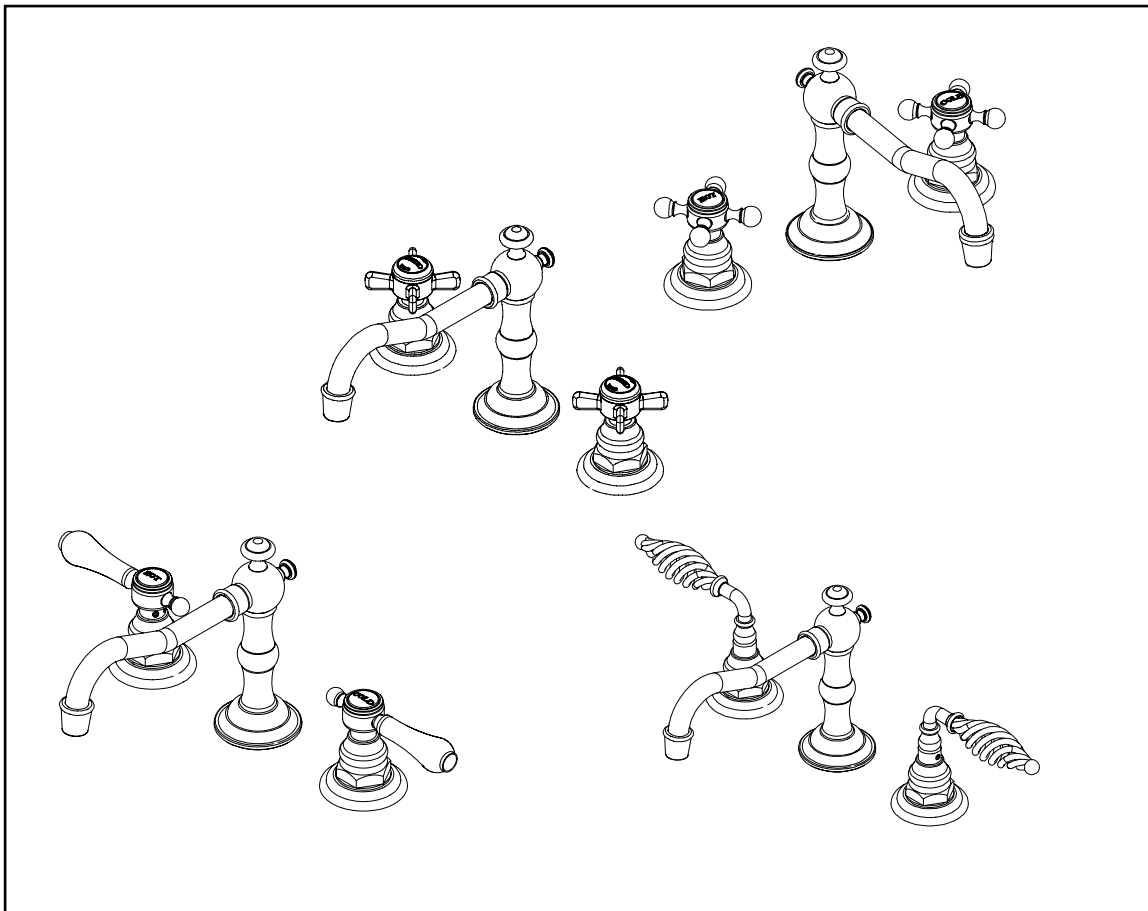

**Congratulations on the purchase
of your Newport Brass product,
an excellent choice, that will give you
years of quality service and enhance
the look and style of your home.**

Recommended Installation by a Professional Plumbing Contractor

Note: The use of petroleum base plumbers putty on our products will nullify the warranty. We recommend the use of clear silicone sealing materials. Recommended deck thru hole \varnothing 1.38"

1. Insert HOSES (3), one at a time, and MOUNTING STUD (4) through sink hole, (apply putty or silicone to underside of Spout base. Align SPOUT (1) and secure into place with GASKET (2), mounting BRACKET (6) and NUT (5). See Figure 1.
2. Place flange NUT (1) and fiber WASHER (2) onto valve BODY (3). Insert valve BODY (3) through sink hole from underside of sink. Valve BODY (3) should extend: 2-3/8" above mounting surface. If necessary adjust lower flange NUT (1). Place fiber WASHER (2a) and flange NUT (1a) onto upper position of valve BODY (3). Set valve BODIES (3) so that their outlets are facing towards the center of the sink and tighten upper flange NUT (1a). See Figure 2.
3. Connect HOSE (4) to outlet of each valve BODY (3). Hand tighten and secure each HOSE (4) with a wrench 1/4 turn. See Figure 2.
4. Connect hot/cold water supply to appropriate 1/2" NPSM valve BODY (6), utilizing one of the three following types of risers. Supply risers not included. See Figure 3.
 - a. 1/2" IPS flexible riser: discard rubber nosecone WASHER (12), friction WASHER (13) and coupling NUT (14).
 - b. 3/8" or 1/2" OD bullnose riser: utilize friction WASHER (13) and coupling NUT (14).
 - c. 1/2" copper riser: utilize rubber nosecone WASHER (12), friction WASHER (13) and coupling NUT (14).
5. Place ESCUTCHEON (16) & BONNET (17) onto valve BODY (6). Any adjustments for rotational alignment must be made to the valve BODY (6) - not to the cartridge. (Note: Allow minimum spacing between HANDLE (18) and BONNET (17) to prevent damage to the surface finish.) Secure HANDLE (18) into place with SETSCREW (19). See Figure 4.
6. Remove drain PLUG (21) from FLANGE (22). Place FLANGE (22) and white WASHER (23) through sink drain opening. (Clear silicone may be used in place of white WASHER (23).) From bottom side of sink, place cone shaped rubber WASHER (24) onto FLANGE (22) and slide up against sink bottom. Note: Cone portion of WASHER (24) to face upward. Next slide on clear flat WASHER (25) and secure with flange NUT (26). Place clear WASHER (27) into drain BODY (28) and tighten to FLANGE (22). Apply thread sealant to TAILPIECE (29) and attach to drain BODY (28). Attach TAILPIECE (29) to p-trap drain (not included). See Figure 5.
7. Place drain PLUG (21) into FLANGE (22). Insert pop-up ROD (30) through spout and secure to STRAP (31), approximately 1" from end of ROD (30), with SCREW (32). Insert ball ROD (33) into the drain's rod opening, secure with ball rod NUT (34). Adjust the rise of the plunger and CLIP (35) into place. Adjust ball ROD (33) and pop-up ROD (30) so drain will open and close properly. See Figure 6.
8. Remove AERATOR from spout, turn on water supply, and flush both valves until water is clear. Check for leaks and make any final adjustments required. Re-attach AERATOR to the spout.

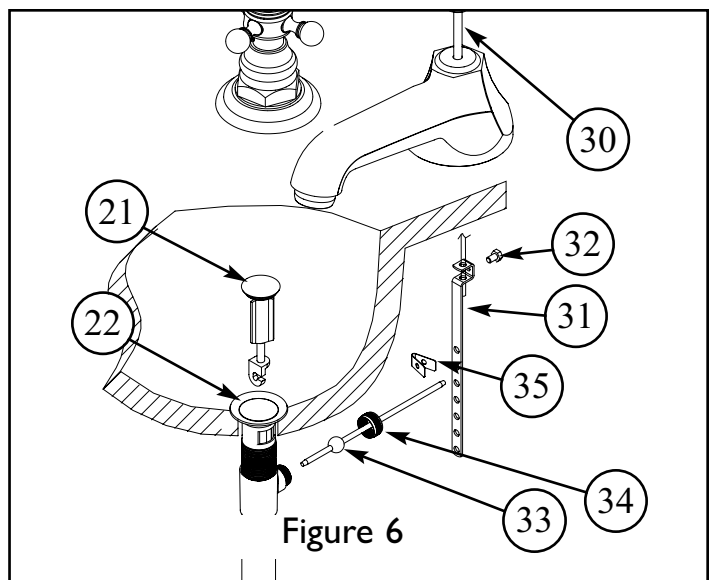
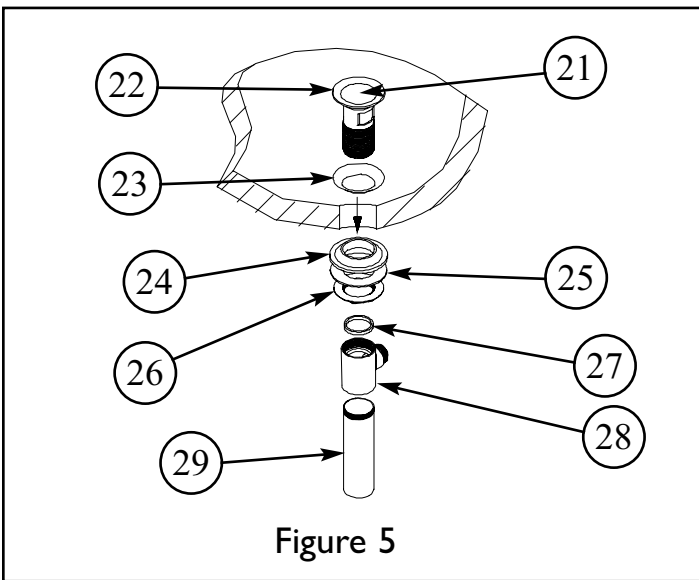
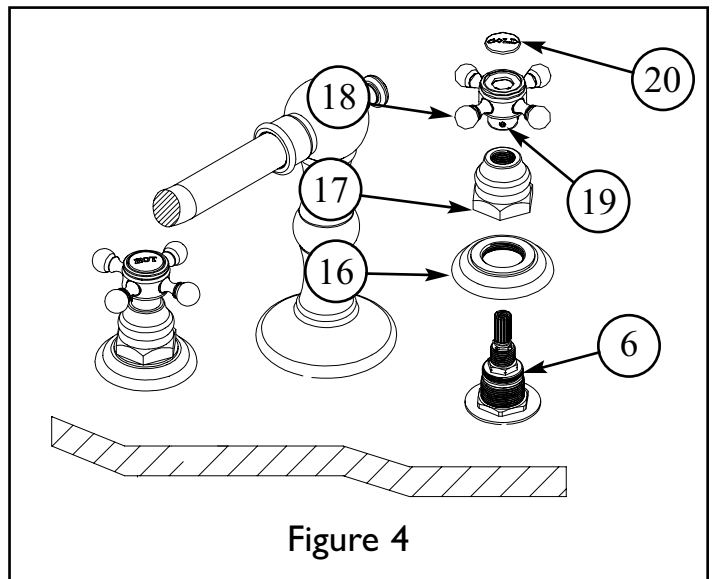
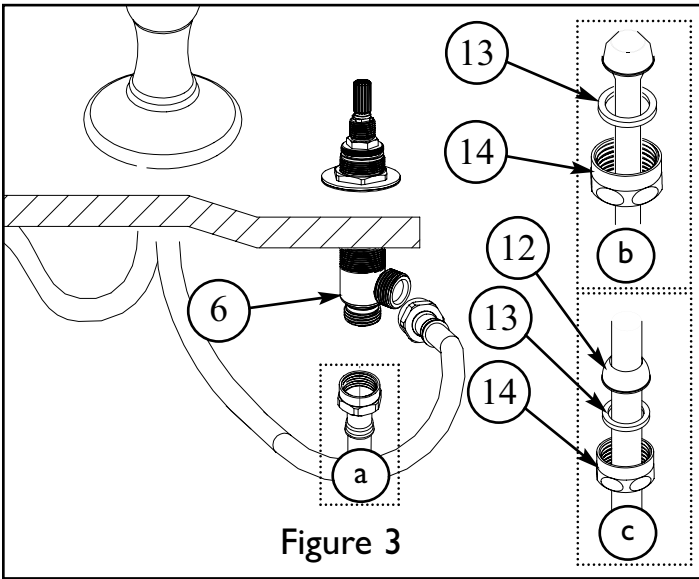
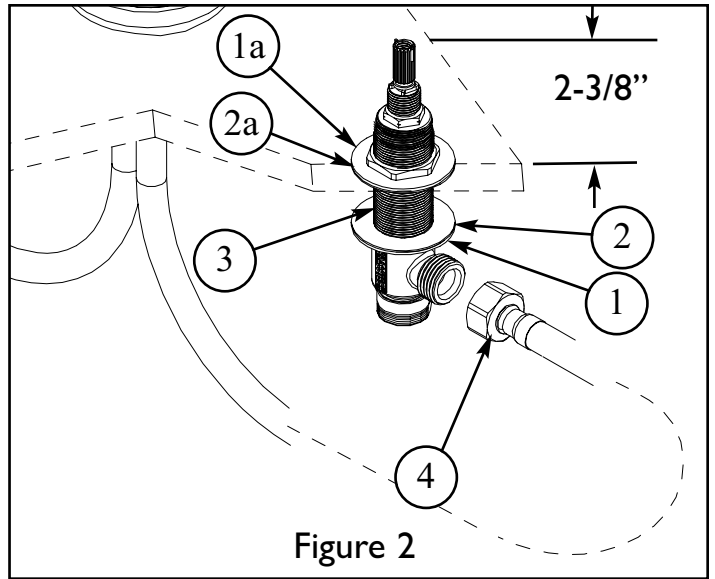
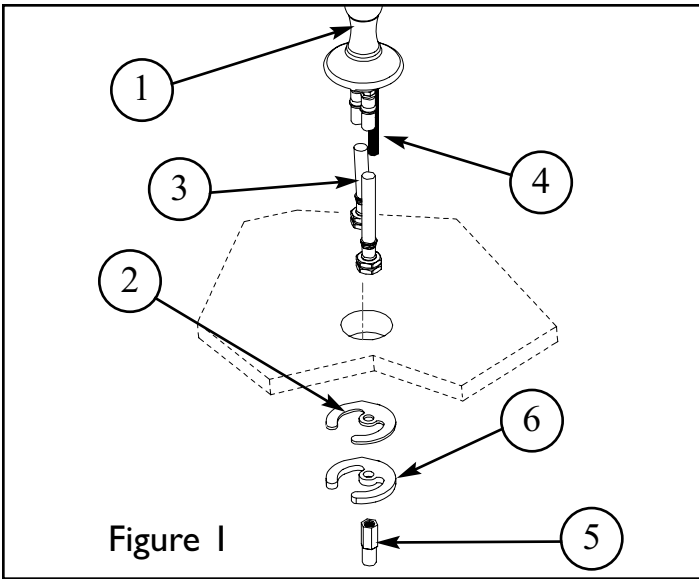

LIMITED WARRANTY

Brasstech, Inc. warrants to the original consumer residential purchaser ("Original Purchaser") that if a product in its; Newport Brass®, Brasstech®, Motiv®, Plumbtrim® or GINGER® lines of products ("Product") is confirmed upon inspection to be defective in materials or workmanship during the warranty periods described below, Brasstech, Inc. will, at its option, either repair or replace the Product with a similar current model of the Product. If repair or replacement is not commercially practical or cannot be made in a timely manner, then Brasstech, Inc. will provide a refund for the Product.

WARRANTY PERIODS AND COVERAGE PRODUCT FINISHES

- PVD and Polished Chrome (26) finishes on Products other than Drains and Shower rods are warranted as long as the Original Purchaser owns their home.
- "Living" finishes and Gold or Silver finishes, have no warranty*. These include 03W, 03N, 08W, 24, 24S, 25 & 25S.
- Shower rods, porcelain parts and glass parts have no finish warranty.
- All other finishes are warranted for ten (10) years from date of purchase by the Original Purchaser.

DRAIN FINISHES

- Polished Chrome (26) and PVD finishes on kitchen, bath or lavatory drains of all types ("Drains") are warranted for one (1) year from date of purchase by the Original Purchaser.
- All other Drain finishes have no warranty.

FUNCTIONALITY

- All Product parts except valves are warranted for ten (10) years from date of purchase by the Original Purchaser.
- Ceramic disc valves for the lavatory faucet, tub/ shower and roman tub are warranted for as long as the Original Purchaser owns the home.
- All other valves (balance pressure, thermostatic, etc.) are warranted for one (1) year from date of purchase by the Original Purchaser.
- Lights have no functional warranty. Soap / Lotion pump mechanisms are warranted for one (1) year from date of purchase by the Original Purchaser.
- Shower rods, porcelain parts and glass parts have no functional warranty.

EXCLUSIONS FROM COVERAGE

- This Warranty does not cover labor charges or associated costs for, or damages occurring during the removal, transportation, return or installation of Products or replacement Products.
- This Warranty does not cover damage or defects due to normal wear and tear, misuse, abuse, hard water, improper storage, improper handling, improper maintenance**, improper installation*** or uses other than normal household usage****.
- This warranty is non-transferable.
- Products sold to customers for use as display items are not meant for resale and are not covered under any functional or finish warranty.

LIMITATIONS ON REMEDIES

In no event will Brasstech, Inc. be liable for incidental or consequential damages (such as labor charges), whether based on breach of express or implied warranty, breach of contract, negligence, strict liability or any other legal theory. Some states do not allow the exclusion or limitation of incidental or consequential damages, so, the above limitation or exclusion may not apply to you. Any implied warranties, including the implied warranties of merchantability and fitness for a particular purpose, are limited to the duration of this written warranty. Some states do not allow limitations on how long an implied warranty may last, so the above limitation may not apply to you.

WARRANTY SERVICE

To obtain service under this Warranty, please contact your Product dealer. If you are unable to locate your dealer, please call 949-417-5207 or access the Brasstech, Inc. website at www.brasstech.com. Proof of purchase, such as the original receipt, is required for the dealer to issue credit to the consumer. The dealer must be an authorized dealer and the product must be purchased in the original manufacturer's packaging (display items excluded).

STATE REMEDIES

This Warranty gives you specific legal rights, and you may have other rights which vary from state to state.

PRODUCT CARE

Simple care is all that is needed in maintaining this product. Abrasive cleansers, detergents and silver or brass polish may result in damage to the finish and therefore should not be used. To clean, simply wipe with a soft, water dampened cloth. Ginger hand, deck and wall shower sprays feature easy-cleaning jets. The jets should be cleaned periodically by rubbing your thumb or a damp cloth across the jets to loosen mineral deposits. Run the shower spray briefly to purge the loosened deposits.

* UNCOATED AND LIVING FINISHES

Uncoated and Living finishes such as Polish Brass Uncoated (03N) and living finishes such as Weathered Brass (03W) and Weathered Copper (08W), do naturally weather and change color over time. Living and uncoated finishes are not warranted.

** MAINTENANCE

Proper maintenance is required to preserve all finishes. Do not use any abrasive cleaners, alcohol, ammonia, detergents, or brass or silver polish on the Products. For complete care requirements and recommendations, please visit our website at www.brasstech.com.

*** PROPER INSTALLATION

Products must be installed in accordance with the manufacturer's installation instructions supplied with the Products. For example, pipes must be flushed before faucet installations, because solder and other debris may damage ceramic discs. You may also call 949-417-5207 for copies of the installation instructions. Many of our installation instructions are also available on our website, www.brasstech.com.

**** COMMERCIAL PURCHASERS

Brasstech, Inc. extends the above limited warranty to purchasers of Products for industrial, commercial and business use upon the same terms and conditions and exclusions applicable to residential purchasers, except that the finish and functionality warranty periods are reduced to a period of one (1) year from the date of purchase. ADDITIONALLY, with respect to commercial purchasers, all implied warranties, including the implied warranties of merchantability and fitness for a particular purpose are excluded and disclaimed.