

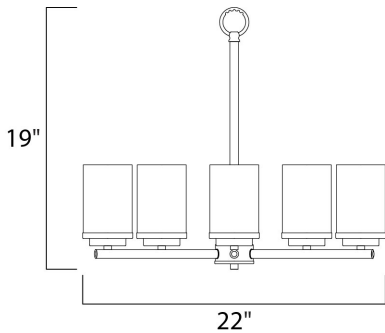

**PRODUCT DESCRIPTION**

Minimalistic frames finished in your choice of Oil Rubbed Bronze or Polished Chrome support cylinders of Frost glass shades. A clean contemporary look at a very affordable price.





**MEASUREMENTS**

DIMENSION : 22" L x 22" W x 19" H  
 CANOPY : 5.12" W x 0.79" H x 5.12" L  
 HANGING WEIGHT : 8.76 lb

**LAMPING**

INPUT VOLTAGE : 120V  
 BULB : 5 x 60W Incandescent E26 Medium , 300W Total  
 BULB INCLUDED : (Not Included)  
 DIMMABLE : Yes

**FINISHES OPTION**

-  Black
-  Satin Nickel

**GLASS**

Frosted FT

**MATERIAL**

Steel, Glass

**RATINGS**

cULus  
 Dry Location



**ADDITIONAL**

ADJUSTABLE  
 OPERATING TEMPERATURE:  
 -20°C (-4°F), 40°C (104°F)

Always consult a qualified electrician before installing any lighting product.



**WESTERN DISTRIBUTION CENTER (HEADQUARTER)**  
 253 NORTH VINELAND AVE | CITY OF INDUSTRY, CA 91746

**EASTERN DISTRIBUTION CENTER**  
 4200 SHIRLEY DR. | ATLANTA, GA 30336

P. 626.956.4200 | F. 626.956.4225 | maximlighting.com