

Features

- Complements Purist® Suite

ACCESSORIES K-14435

Codes/Standards Applicable







Specified model meets or exceeds the following:

- None applicable

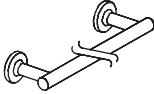
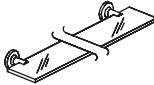
Colors/Finishes

- CP: Polished Chrome
- Other: Refer to Price Book for additional colors/finishes

Specified Model

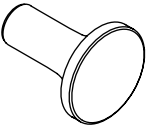
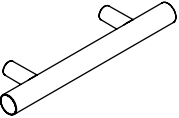
Model	Description		Colors/Finishes	
K-14435	18" (45.7 cm) towel bar		<input type="checkbox"/> CP	<input type="checkbox"/> Other_____
K-14436	24" (61 cm) towel bar		<input type="checkbox"/> CP	<input type="checkbox"/> Other_____
K-14437	30" (76.2 cm) towel bar		<input type="checkbox"/> CP	<input type="checkbox"/> Other_____
K-14440	Glass shelf		<input type="checkbox"/> CP	<input type="checkbox"/> Other_____
K-14441	Towel ring		<input type="checkbox"/> CP	<input type="checkbox"/> Other_____
K-14443	Robe hook		<input type="checkbox"/> CP	<input type="checkbox"/> Other_____
K-14444	Toilet tissue holder		<input type="checkbox"/> CP	<input type="checkbox"/> Other_____
K-14445	Soap dish		<input type="checkbox"/> CP	<input type="checkbox"/> Other_____
K-14447	Tumbler and holder		<input type="checkbox"/> CP	<input type="checkbox"/> Other_____
K-14484	Knob cabinet hardware		<input type="checkbox"/> CP	<input type="checkbox"/> Other_____
K-14485	Pull cabinet hardware		<input type="checkbox"/> CP	<input type="checkbox"/> Other_____

Product Specification

Product shall complement the Purist Suite. Product shall be Kohler Model K-____-____.

PURIST®

Installation Notes

Install this product according to the installation guide.

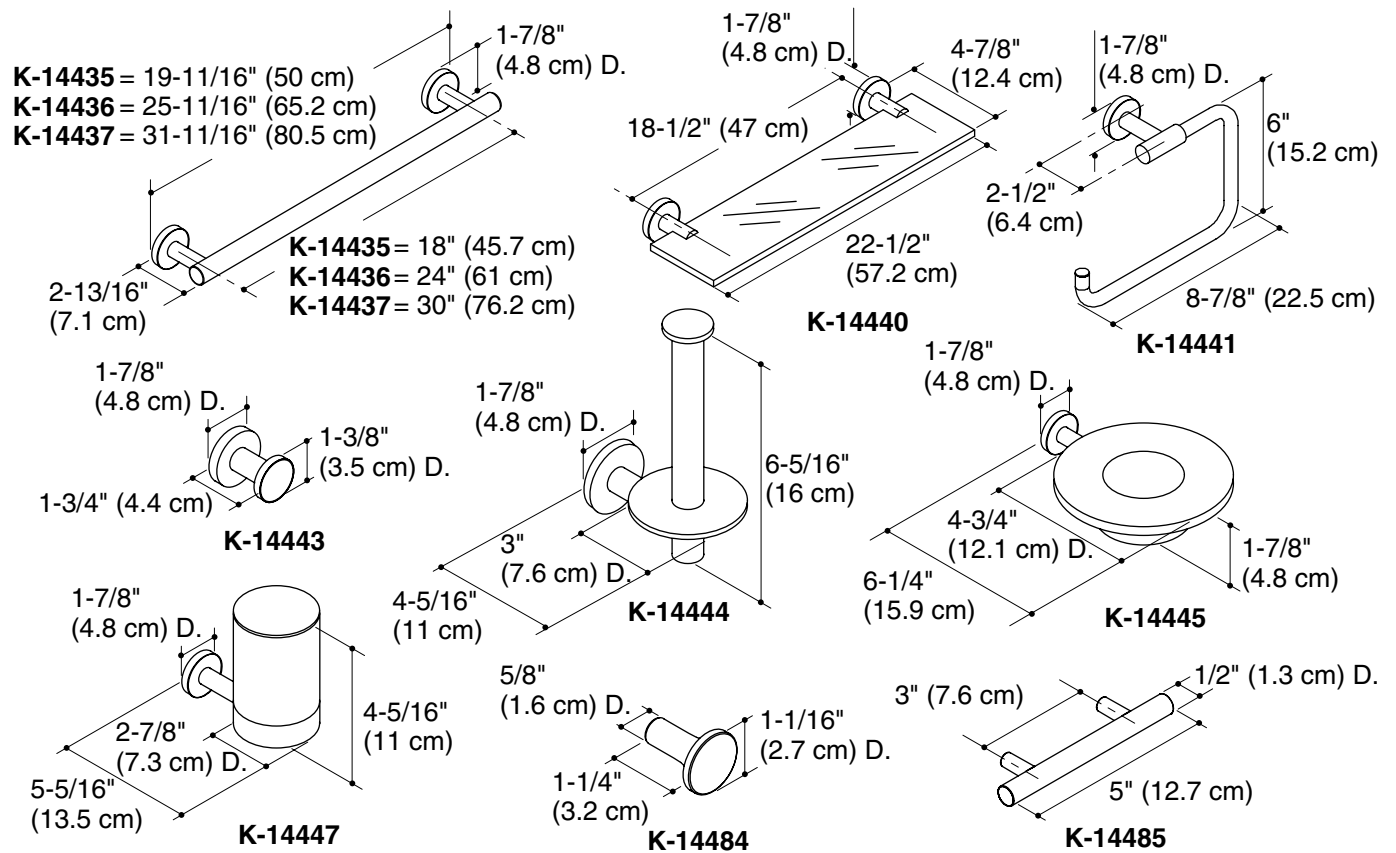

Product Diagram