

SPECIFICATIONS

SHOWER ACCESSORIES

Description

- All extension shower arms increase the range of the showerhead
- All brass construction

Standards



• UPC/cUPC

Warranty

Danze products are covered by a manufacturer's limited "lifetime" warranty for manufacturing defects.



D481144 - 15" SIRIUS™ shower arm

Available Colors & Finish

- Chrome
- Brushed Nickel (BN)



D481116 - 13" S shape shower arm

Available Colors & Finish

- Chrome
- Antique Copper (AC)
- Brushed Nickel (BN)
- Chrome with Polished Brass Accents (CPBV)
- Polished Brass (PBV)
- Oil Rub Bronze (RB)
- Stain Black (BS)

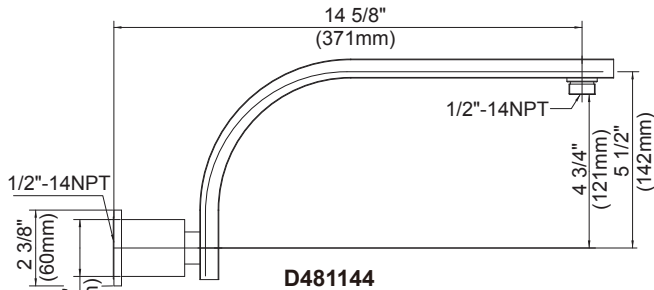

D481144



D481026 - 12" right angle shower arm

D481027 - 15" right angle shower arm

D481026 Available in :

- Chrome
- Brushed Nickel (BN)

D481027 Available in :

- Chrome
- Brushed Nickel (BN)
- Polished Brass (PBV)
- Oil Rub Bronze (RB)

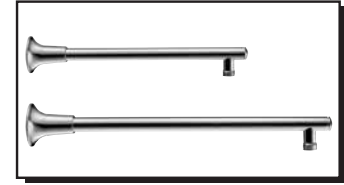

D481237 - 12" J shape shower arm

D481238 - 15" J shape shower arm

Available Colors & Finish

- Chrome
- Brushed Nickel (BN)

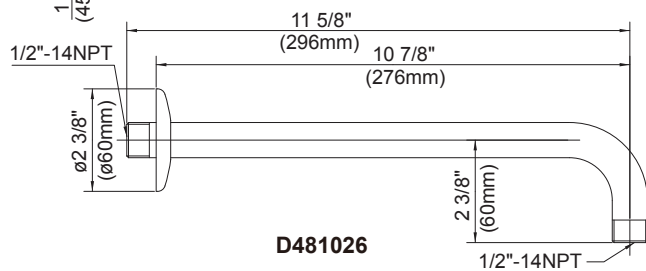

D481026

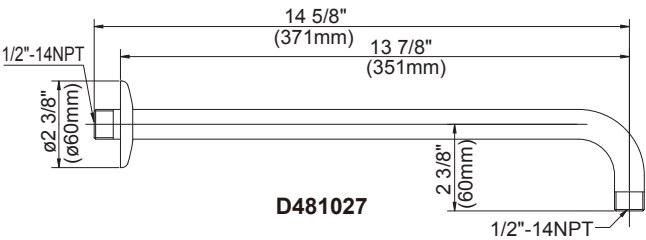

D481027

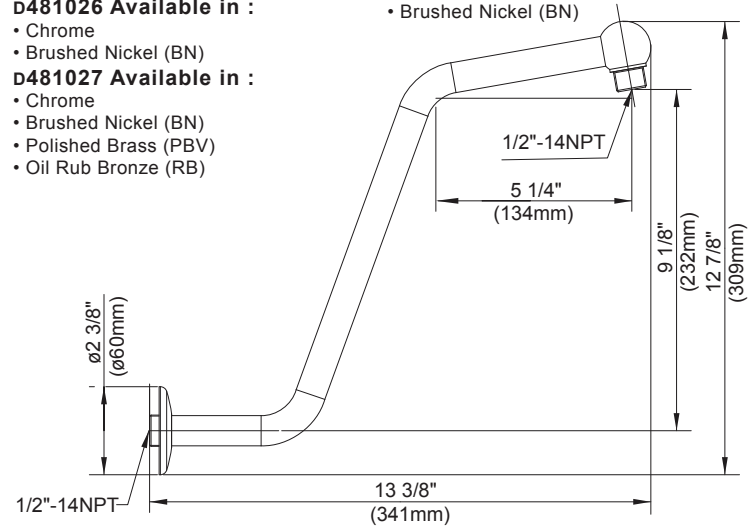

D481116

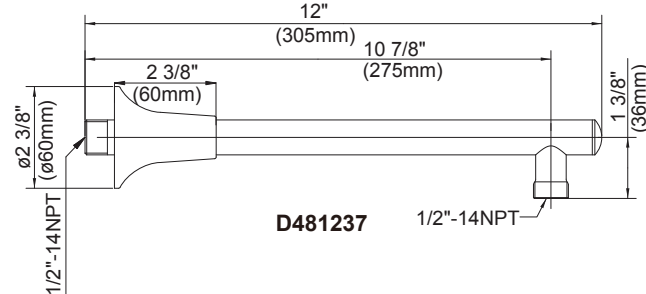

D481237

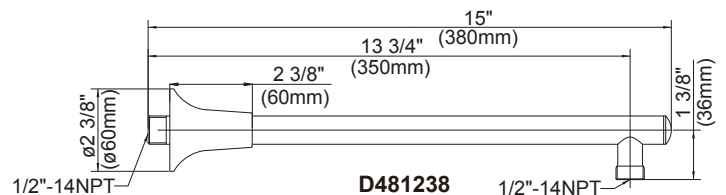

D481238

Submittal Information:

Job Name: _____

Location: _____

Contractor: _____

Contact #: _____