

SPECIFICATIONS

Features/Benefits

- SnapBack[®] Retraction System
- Easily Adjustable GripLock[®] Weight
- 14 3/4" Spout Height, 6 7/8" Spout Reach
- 1.75 gpm (6.6 L/min) Max Flow @ 60 psi
- 2 Function Spray/Aerated Stream
- Ceramic Disc Cartridge
- 300 Degree Swivel Spout
- Single Hole Installation
- Optional Deck Plate, DA667229(4") or DA665051 (8"), Sold Separately



Available Color/Finishes

Color	Description
-------	-------------

Chrome

Please see danze.com or current price list for available finishes. Finish is defined by additional suffix.

Standards & Certifications

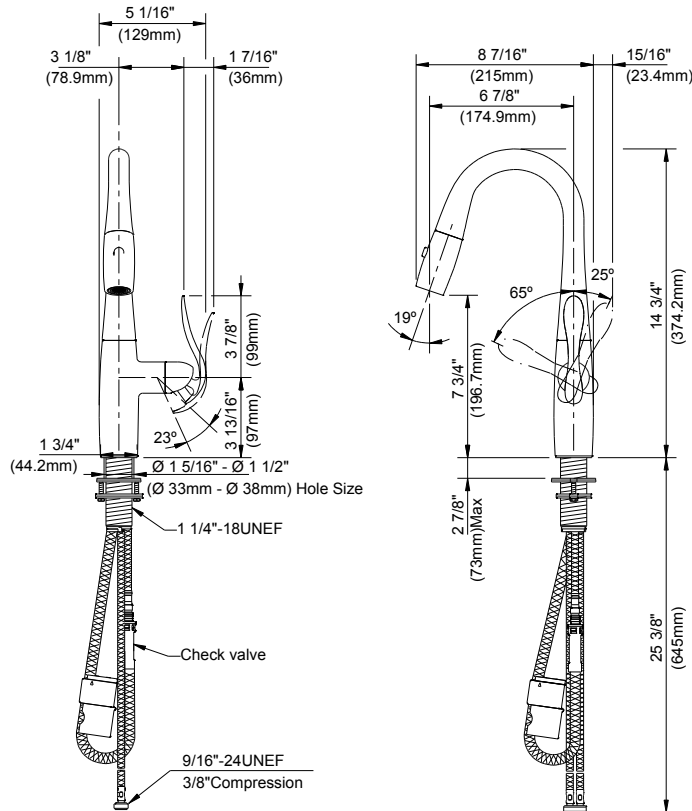

Submittal Information:

Name: _____
Location: _____

Contractor: _____
Contact #: _____