

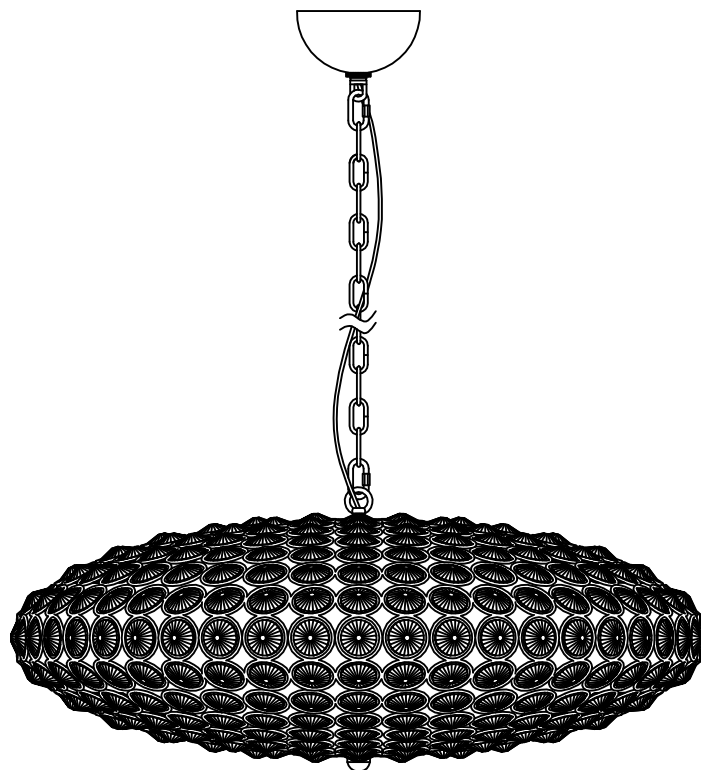

Contemporary Lighting

PRODUCT NAME: Brilliant
ITEM NUMBER: E24013-20PC

Please consult your electrician for hanging fixture and wiring.



Caution: Xenon bulbs get very hot and may burn you. Always make sure bulbs are off for a minimum of 10 minutes before handling. Fixture may be dimmed using an electronic low voltage dimmer.

Bulbs (Included): 12*40Watt G9

IMPORTANT: Turn off the power at the main fuse or circuit breaker box before starting installation

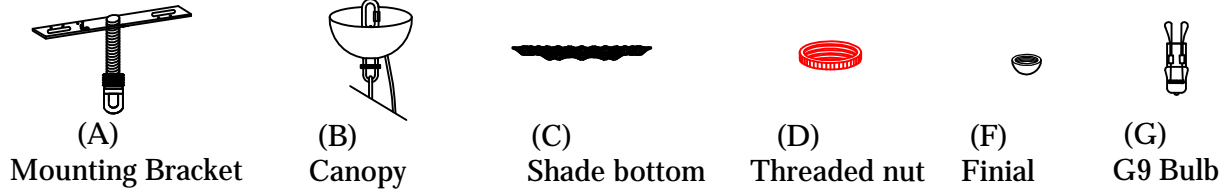

Locate all hardware & components before discarding packaging

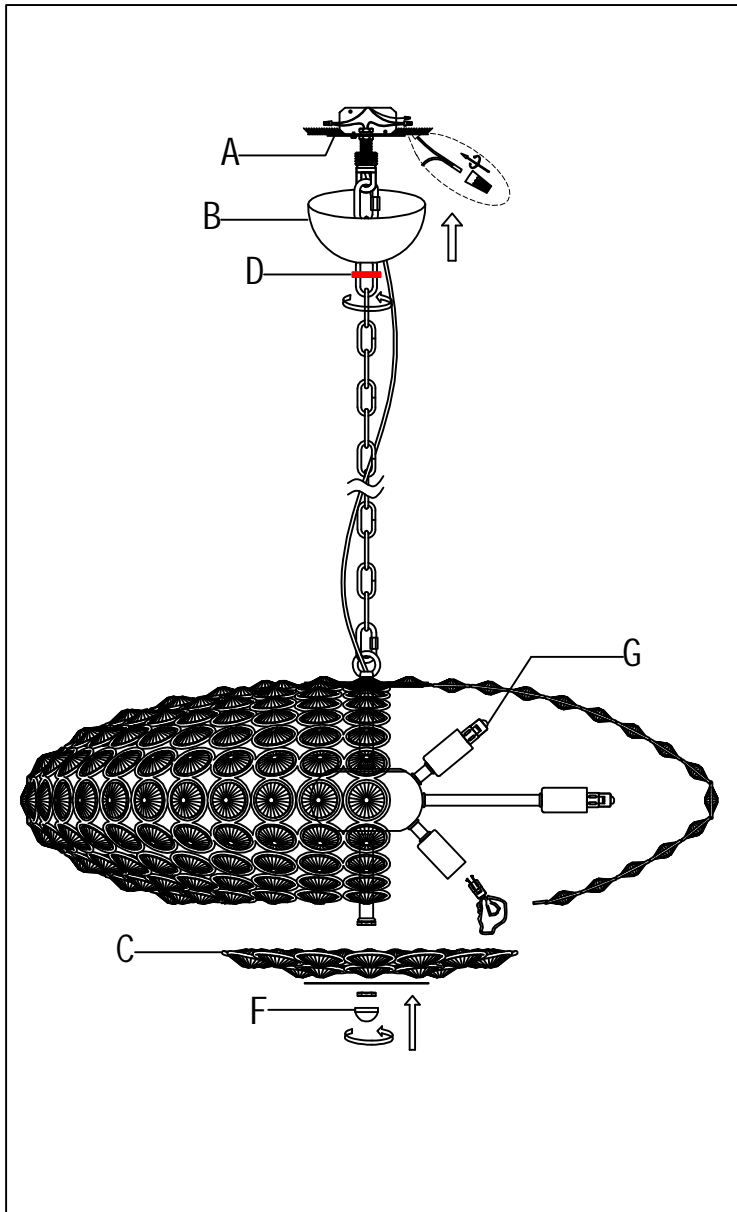

Cleaning & Care:
Clean with soft cloth and a mild detergent.
Do not use abrasive cleaner.

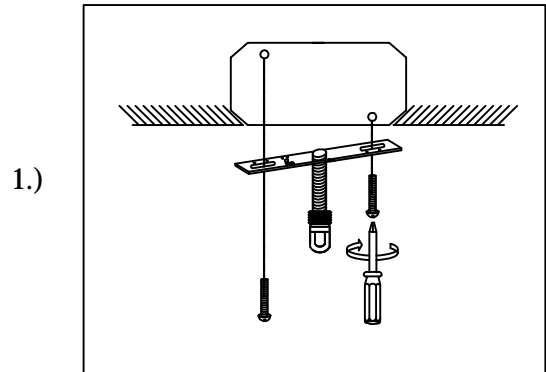

1.) Step.1: Remove mounting bracket (A) from fixture and install to electrical box.

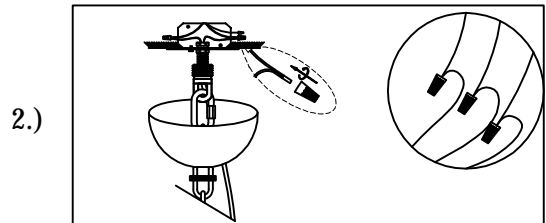

2.) Step.2: Wire fixture to wires in outlet box. Green wire is for Ground.

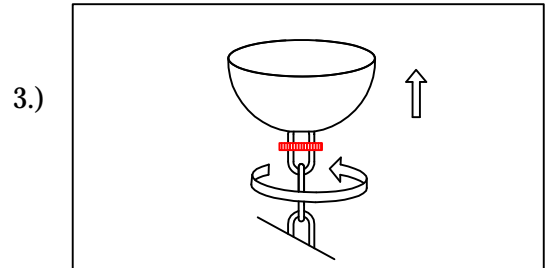

3.) Step.3: Screw Canopy (B) onto mounting bracket (A) by tightening the threaded nut(D) until canopy is flush with ceiling.

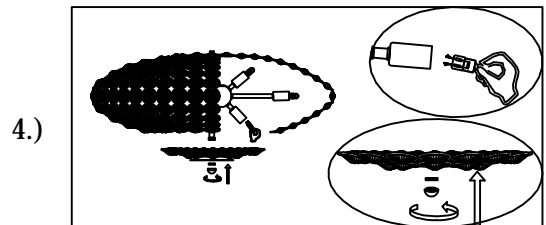

4.) Step.4: Install G9 bulbs (G) and fix shade bottom (C) to the shade by finial (F).